



志航科技股份有限公司

品質 誠信 創新 專業





創立時間：2006/01/01

董事長：林子玉

資本額：10500萬

員工人數：550人

主要股東：東莞宜特五金塑膠有限公司

佳那企業有限公司

製造工廠：大陸東莞宜特廠

大陸深圳陽極廠





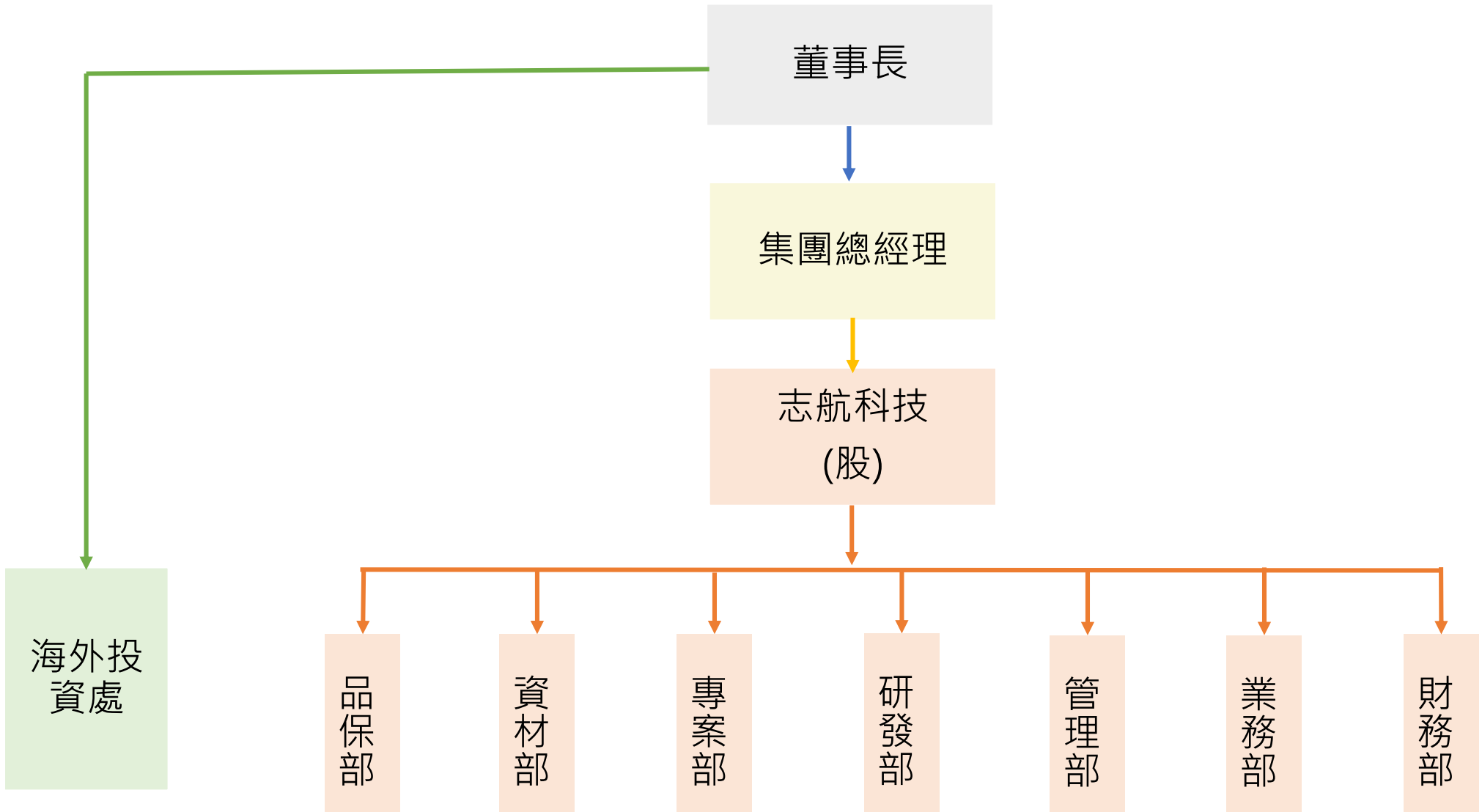

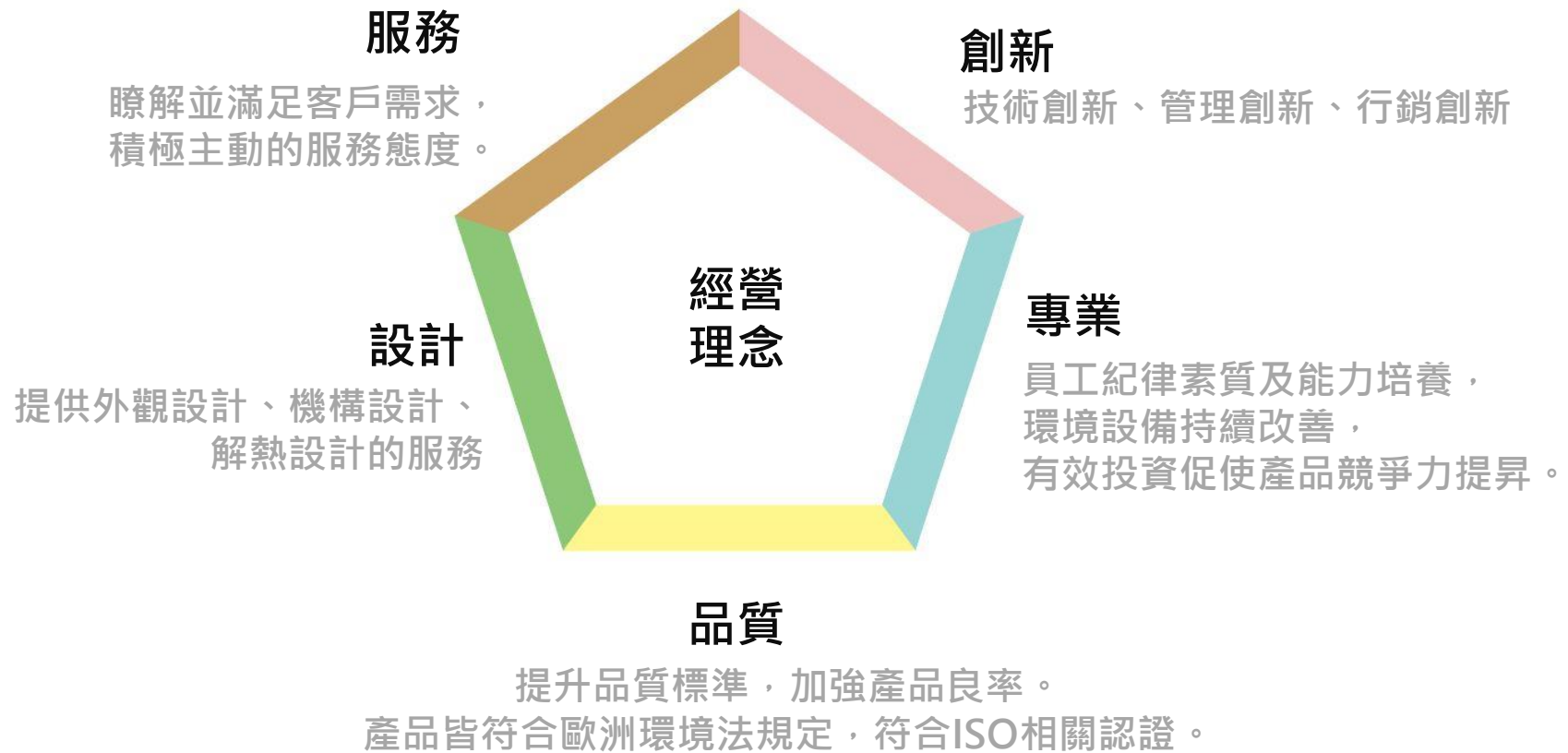



GIGABYTE™

Ennovations Connected!
Innoconn
An Innovative Foxconn Member!

SonoScape



 **FOXCONN**
富士康科技集團

COLORFUL®
七彩虹

LITEON®

J&W 杰微

msi™

ECS

QNAP

asustor

Lenovo™

DFI®

ASRock®

wistron®

a value
Technology Inc.

Chicony®



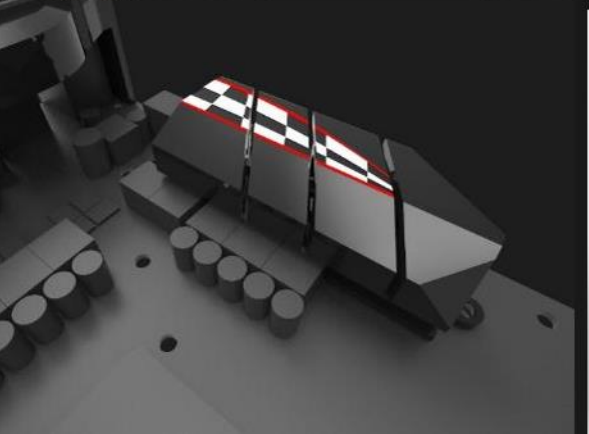
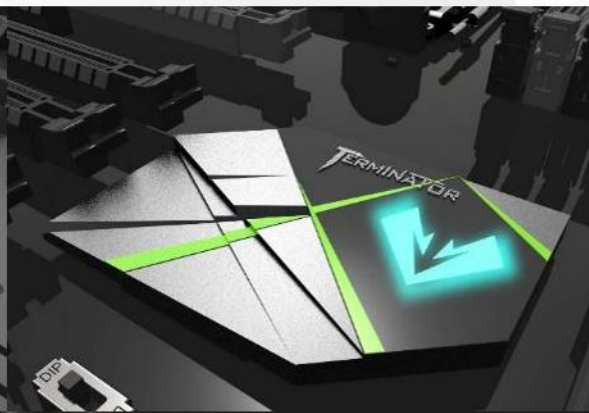
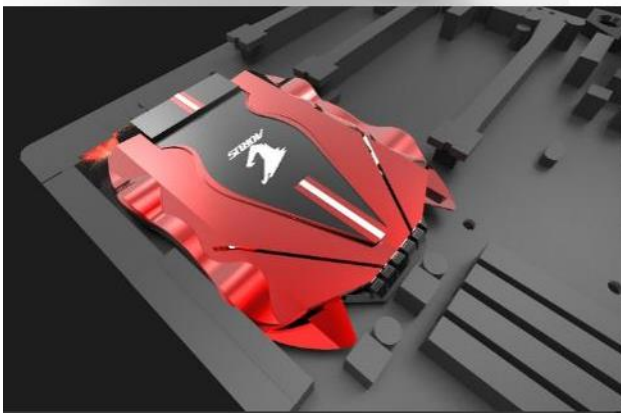



R

RADEON
RX 580

RADEON
RX 570

PHANTOM GAMING

GEAR UP
RADEON™ RX 500 SERIES

RADEON
VR
READY
PREMIUM

The advertisement features two Radeon Phantom Gaming graphics cards, the RX 580 and RX 570, shown from a three-quarter perspective. The cards are black with silver and red accents, and each has two fans with the Phantom Gaming logo. The background is dark with red and white light streaks. The text 'GEAR UP' is prominently displayed in large white letters, with 'RADEON™ RX 500 SERIES' below it in red. The Phantom Gaming logo is in the upper right, and the Radeon VR Ready Premium logo is in the bottom right corner.



Up to **30%** Performance Boost

Sintered Copper Powder
Grooved Design

30-40% LIFESPAN

Traditional Design v.s. Double Ball Bearings

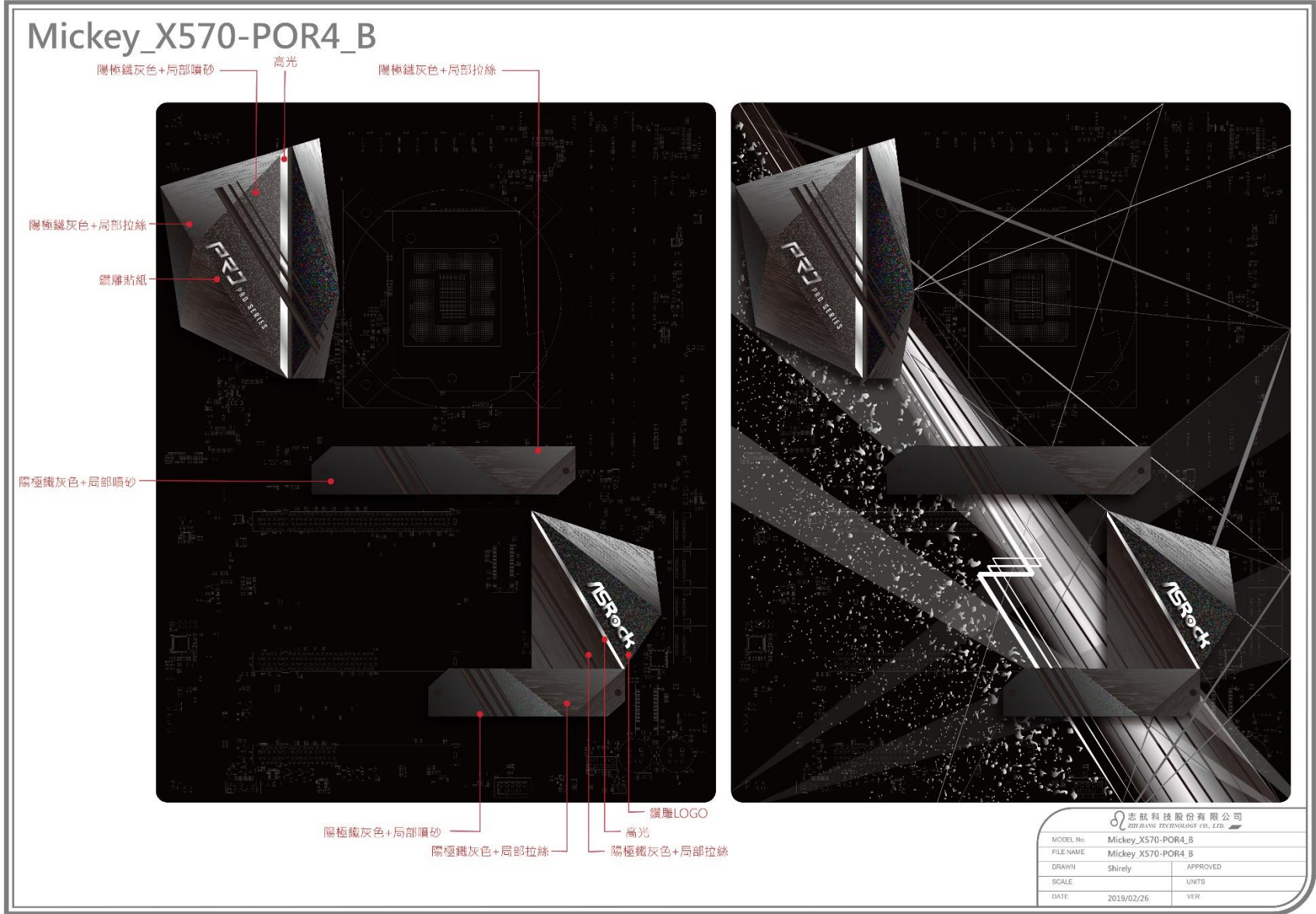

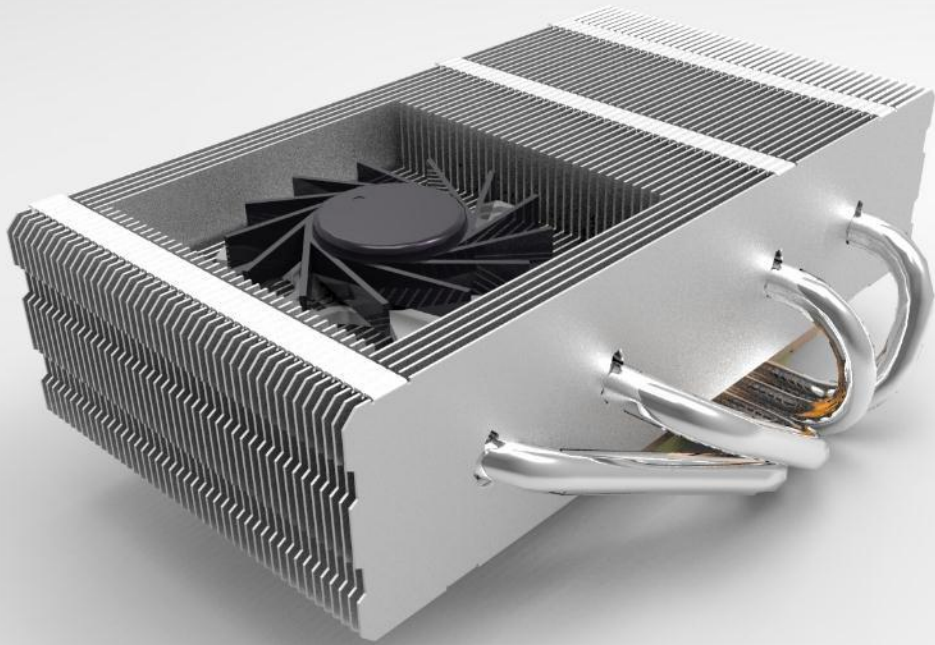



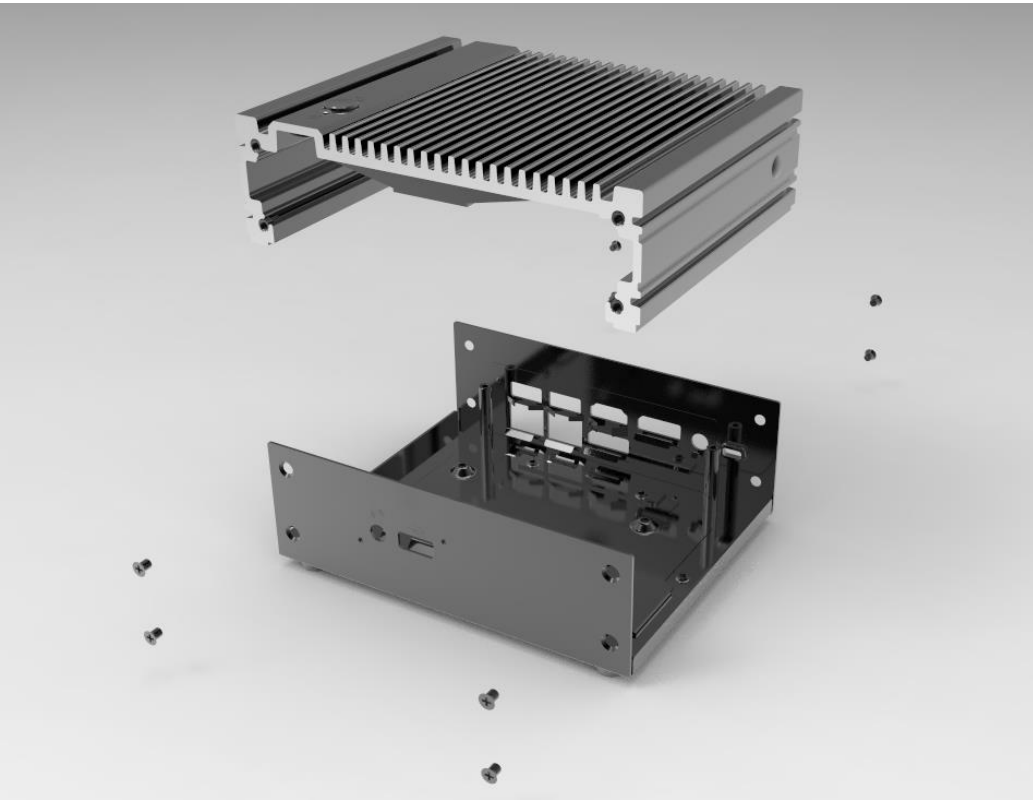



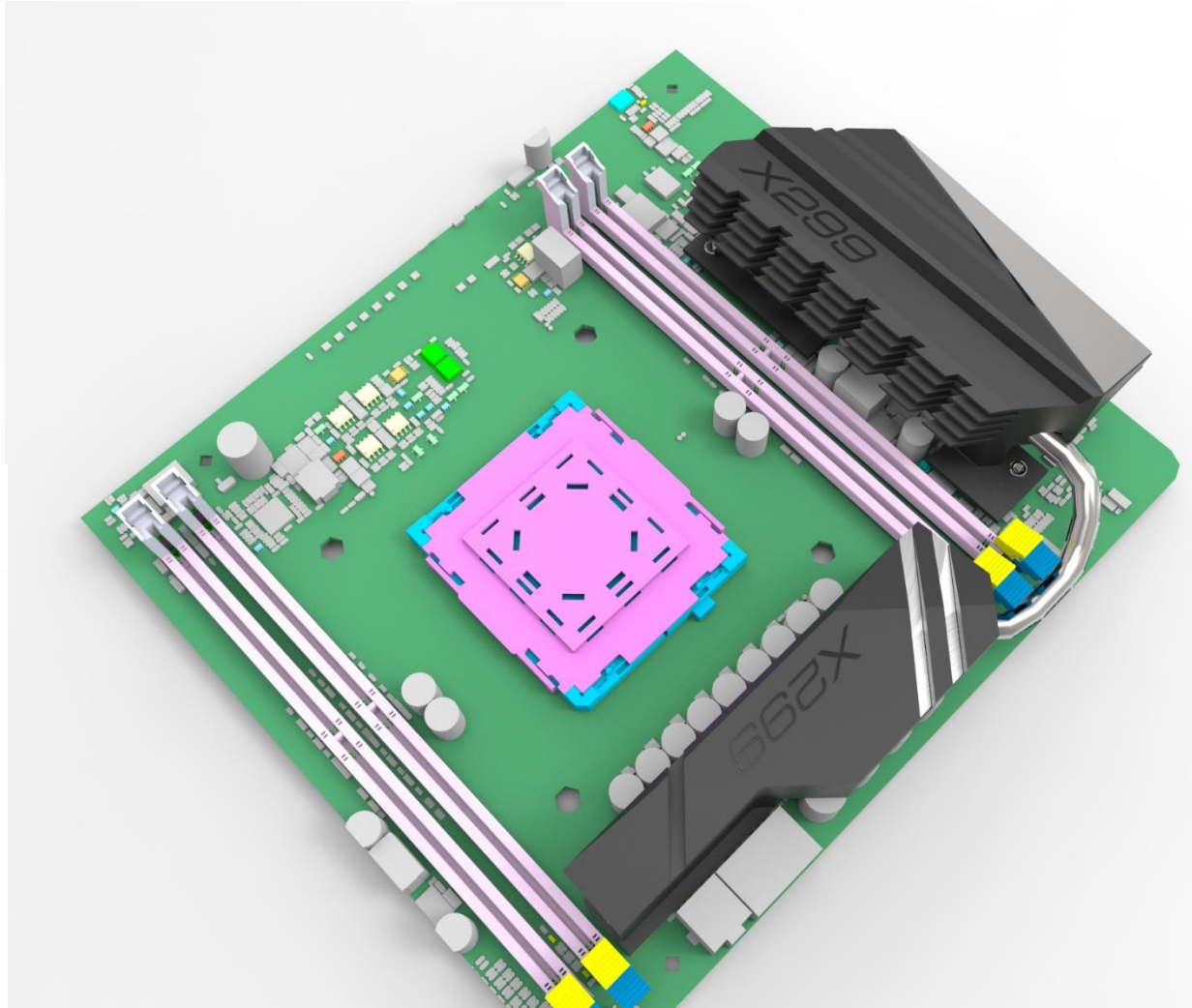
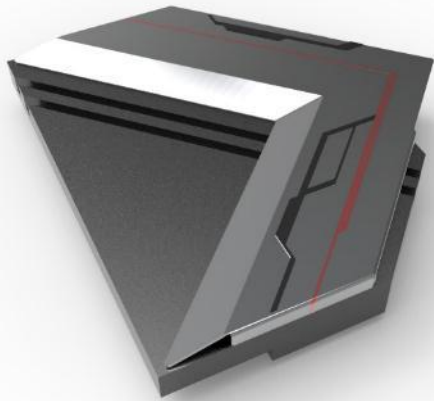
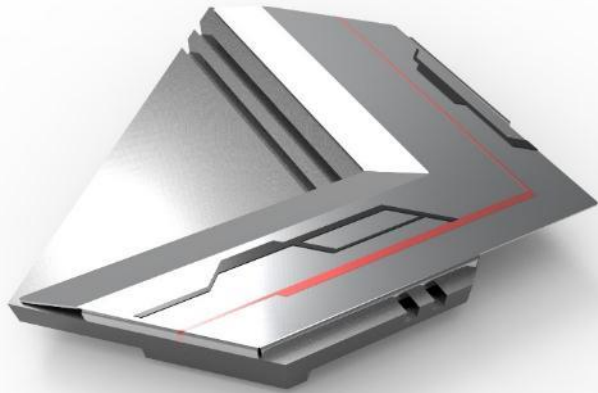

充填时间
= 1.429[s]

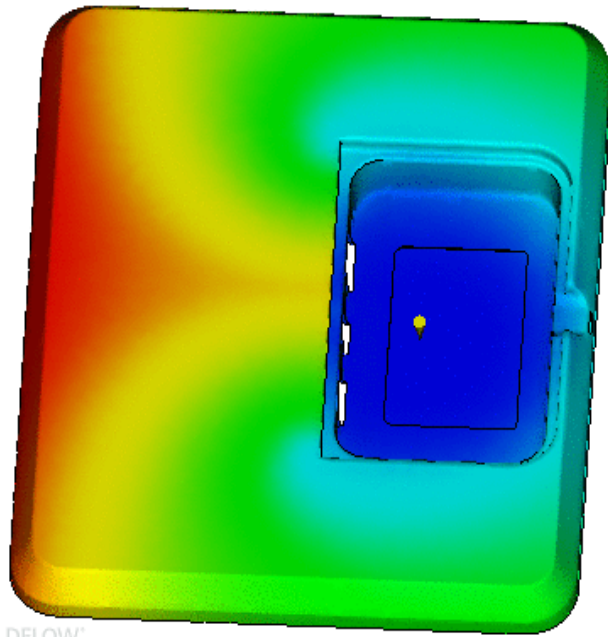
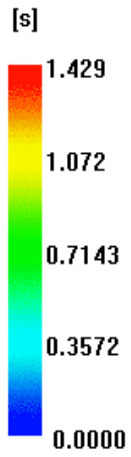

縮放 (100 mm)

AUTODESK
SIMULATION MOLDFLOW
INSIGHT

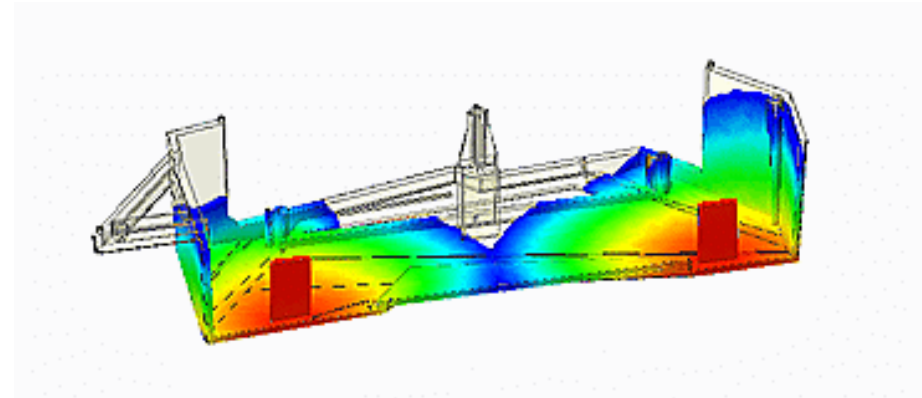
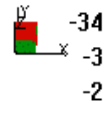

速度/压力切换时的压力
= 63.12[MPa]

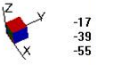
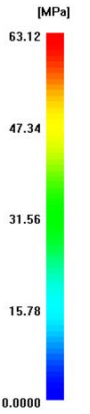

縮放 (100 mm)



6SigmaET
by Future Facilities

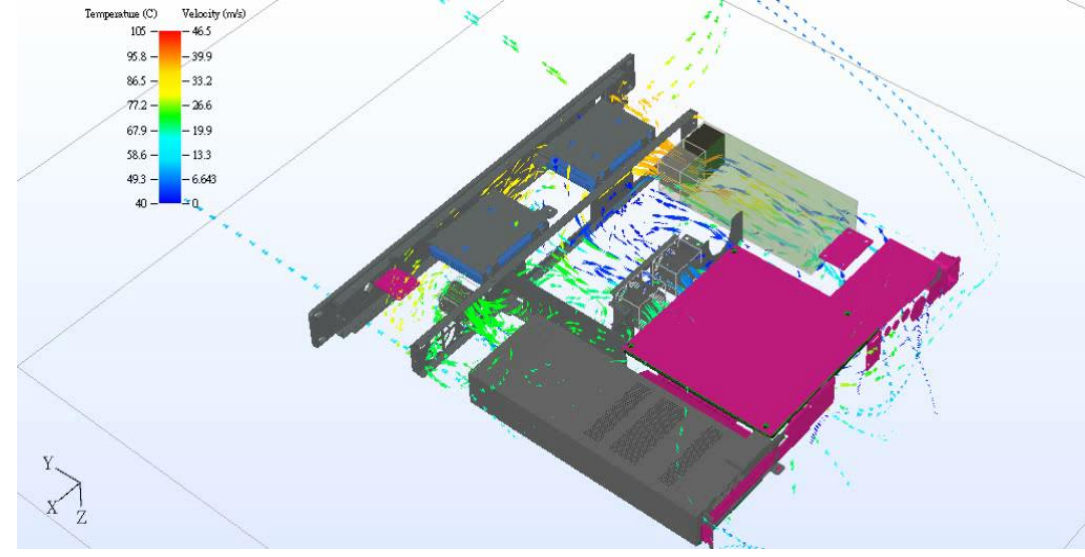
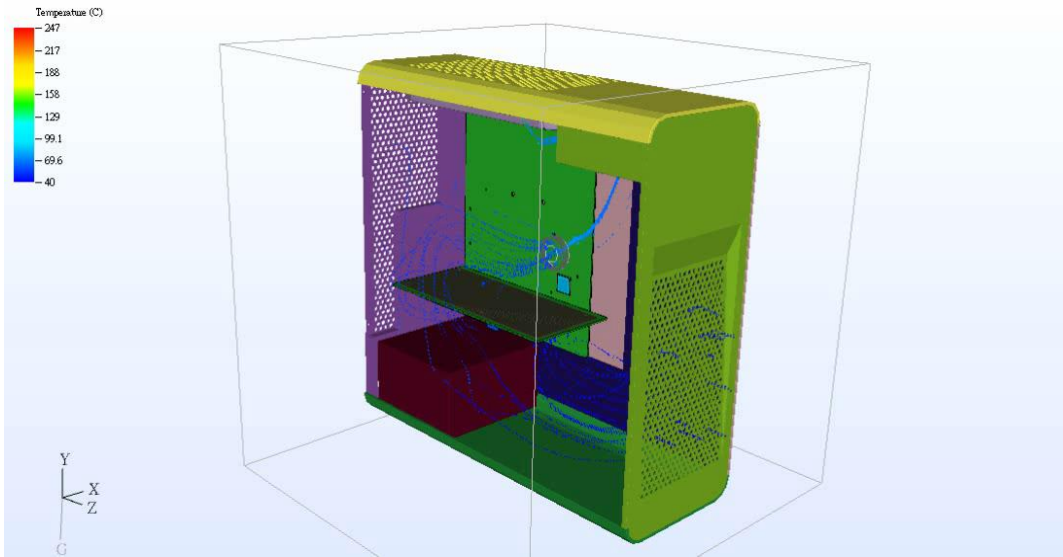



■ 產品效能測試



■ 塑膠3D立體打印機



日產能(8H)

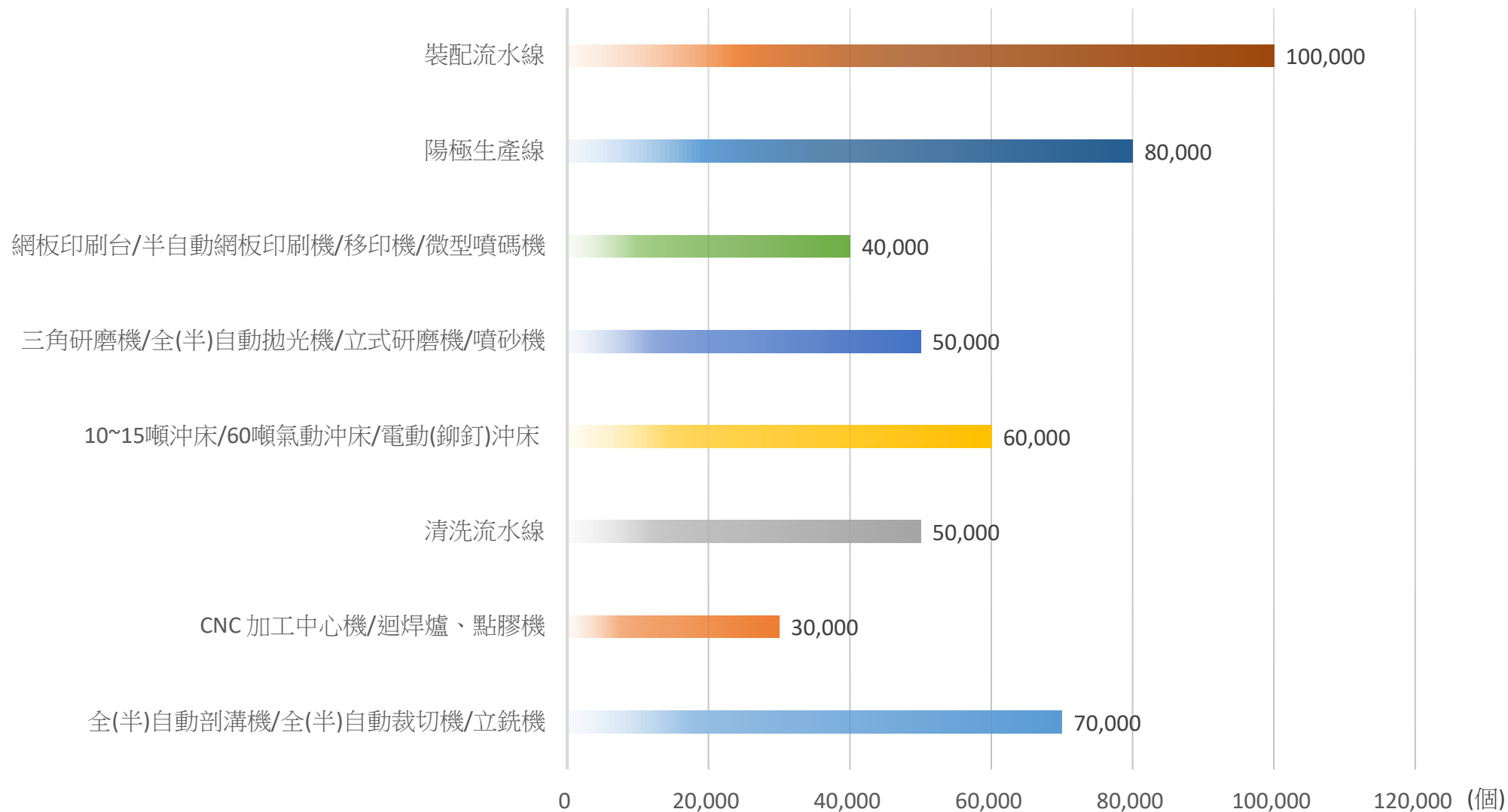

自動剖溝機



木工機

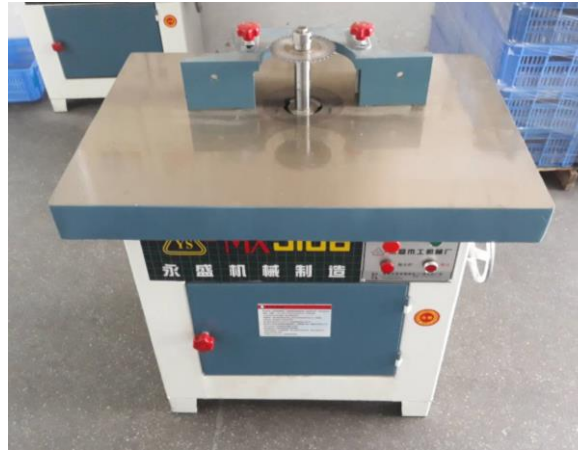

三角研磨機



CNC銑床



陽極電解槽



裝配流水線



陽極A區及下掛區



陽極B區及下掛區



EDM車間



模具車間



注塑機



吹塑機



塑膠噴塗線



雙色注塑成形



沖床(一)



NCT



沖床(二)



模具車間



折彎機



熱阻測試儀

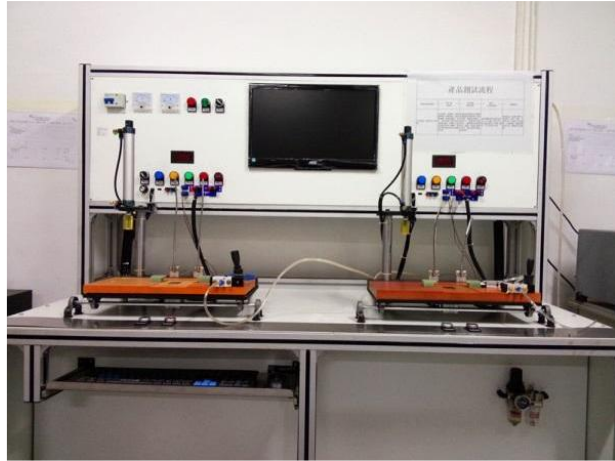

彈簧磅力測試計



投影機



拉拔力測試機



熱管檢測器



扭力計



鹽霧試驗機



耐磨測試機



二次元量測



三次元量測



巴式硬度計



色差計



燈箱



萬能角度規



針規



外徑千分尺



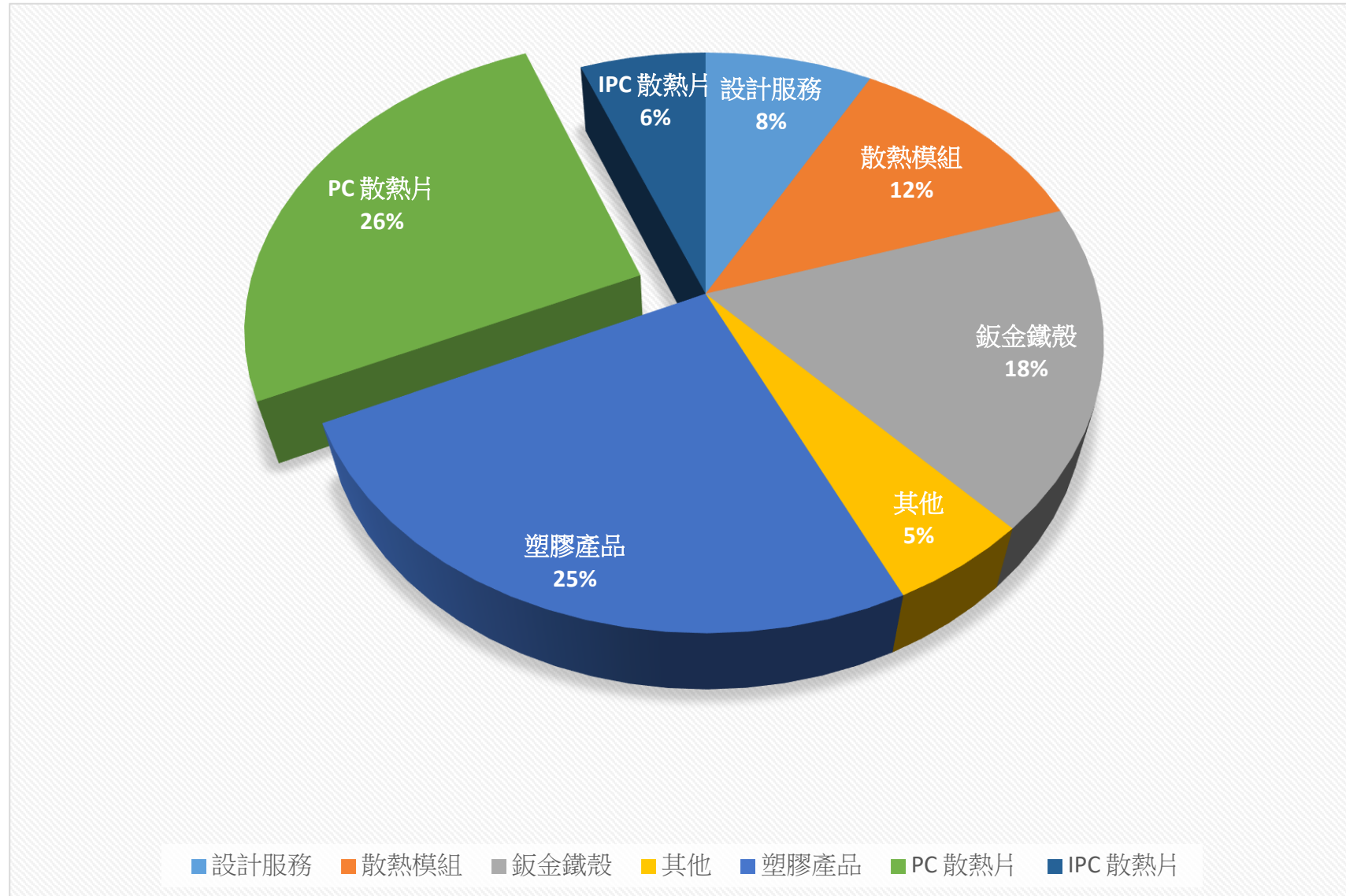

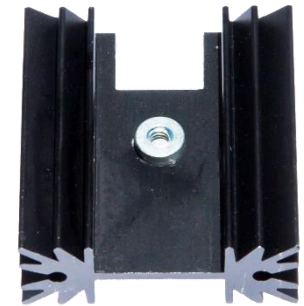
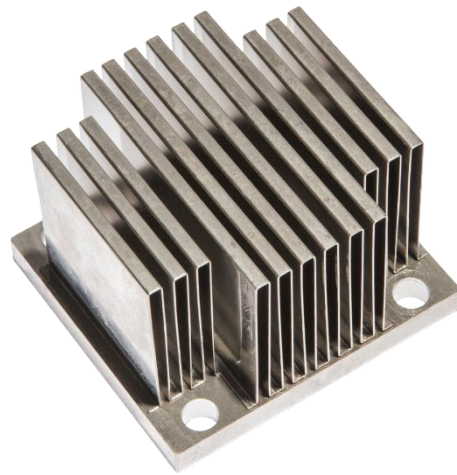
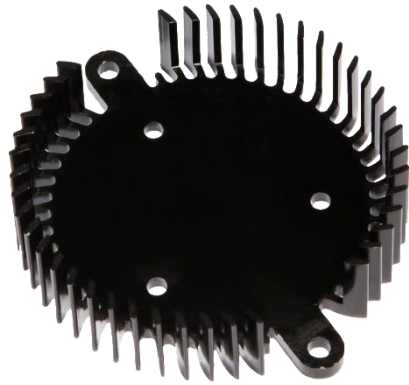

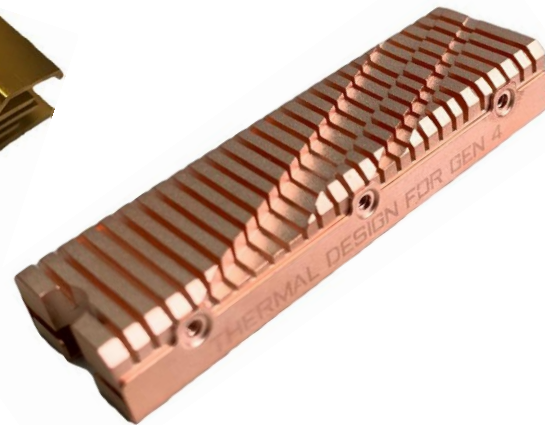
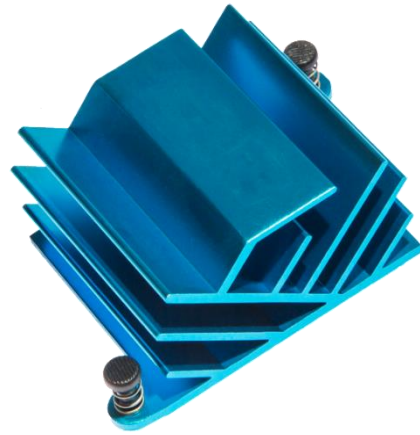











「機會要靠自己創造，不能一昧地守株待兔。機會一旦來臨，更要能沉著面對，並掌握之。」走過十個年頭，志航科技鋪展出康莊大道。展望未來，志航科技多角化、國際化的事業經營也將持續擴展，再創新機。

志航科技的每一次投資，始終配合著時代脈動，並以社會需求為發展前提，不僅滿足目前市場的需要，更積極探索人類未來生活的需求。這種「滿足現在」，更要「預見未來」的前瞻眼光，重視觀念的創新與投注研究發展的識見，推動企業體更大的成長空間，創造出更多的發展機會。

面對日益詭譎多變的世界政經局勢，必然充滿前所未有的艱難挑戰與逆境，但相對地也勢必產生無數的新機會。如何洞察大環境的變化與市場趨勢，掌握投資發展的每一個契機，將是志航科技未來發展的重要關鍵。公司每一個成員，仍將持續發揮堅忍不拔、踏實勇進的企業精神，投注大量心力於研究發展的工作，以更堅實的企業陣容迎接挑戰，並積極擴大對社會的關懷層面，與人們共享更科技、更現代且更溫情的世界。



扶助偏鄉弱勢，獲頒愛心企業殊榮

公司長年重視企業的社會責任（CSR），並與宏國德霖科大會展系蔡顯榮助理教授長期合作，推動偏鄉小學弱勢服務工作，舉辦暑期營隊活動、課輔教學等已逾8年，有超過30所偏鄉小學受惠，其中更有捐助平板電腦、教室照明修繕、畢業旅行經費、家長會農產品營銷，不僅補強學生課業、還強化學校軟硬體、更照顧弱勢學生家庭助其生活改善，2018年獲新北市葉惠青副市長表揚為「優質有愛心的企業」殊榮，媒體更有大幅報導。



2020-07-03 彭慧婉

感謝志航企業捐資改善全校照明設備 溫馨邀林子玉董事長參與畢業典禮

【記者彭慧婉／綜合報導】花蓮縣瑞穗鄉鶴岡國小，6月30日(週二)辦理畢業典禮，與會嘉賓除中央立委代表外，地方有縣府代表、縣議會代表、鄉長、村長、部落頭目、鄰近中小學校長，會場上最吸睛的賓客是來自新北市樹林區的志航科技股份有限公司林子玉董事長。



新新聞

新聞報導 封面故事 專欄評論 特別企劃 新新聞見證六四 每期目錄 新聞

新聞首頁 > 新聞報導 > 生活中心

友善列印

偏鄉小校溫馨畢業 愛心企業相挺 2020-07-03 16:00





台北總公司

地址 : 新北市樹林區佳園路二段61之3號

電話 : 886-2-2668-5886

傳真 : 886-2-2668-9220

<http://www.zhi-hang.com/>

sales@zhi-hang.com

大陸東莞宜特廠

東莞市虎門鎮

大陸深圳陽極廠

深圳市寶安區





志航科技股份有限公司



Thank You 歡迎與我們聯繫



886-2-2668-5886



sales@zhi-hang.com



23880新北市樹林區佳園路二段61-3號